

Produktdatenblatt

Beschreibung:

VHS 612H - 30 mm

VHS 612H - 30 mm
Vorhangschloss, Messing, VS, 2 Schlüssel,
gehärteter Stahlbügel, Bügel 40,0 x 5,0 mm,
mit Wasserstop

Abbildung:



Technische Daten:

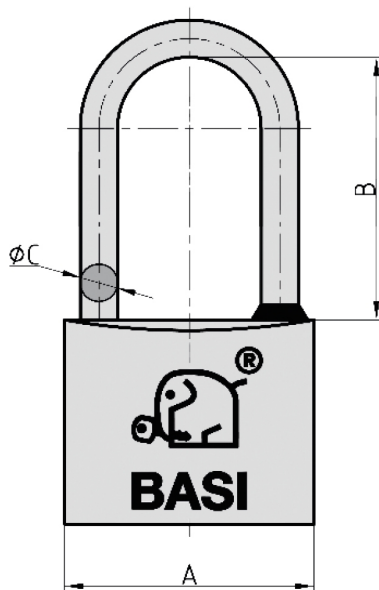

Ausführung:

Bestell-Nr.
6121-3000
Gewicht
114 g
Preisgruppe
15
EAN
 4 026434 101447

Konstantinstraße 387
41238 Mönchengladbach
Germany

Tel. +49 (0) 21 66 / 98 56-0
Fax +49 (0) 21 66 / 98 56-55

info@basi.eu
www.basi.eu

Alles in Sicherheit

